

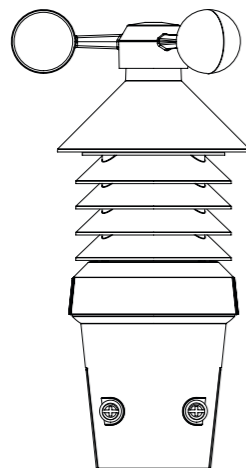

# Digital Weatherstation PLUS

USER MANUAL | Product Code 719035

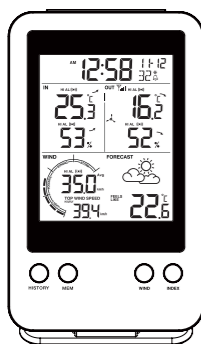

## OVERVIEW LCD MONITOR

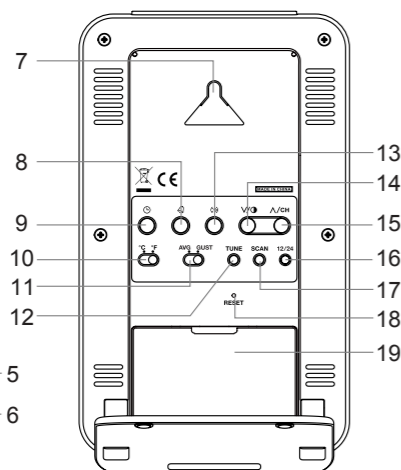
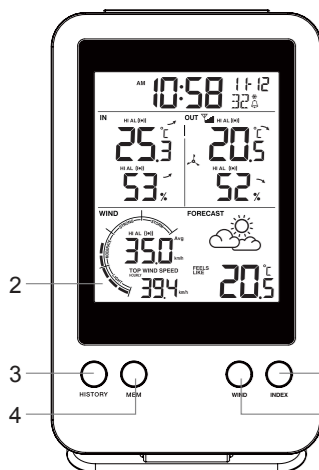
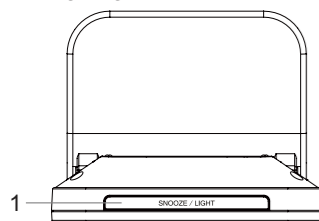

- 1. [ SNOOZE / LIGHT ] key
- 2. LCD display
- 3. [ HISTORY ] key
- 4. [ MEM ] key
- 5. [ INDEX ] key
- 6. [ WIND ] key
- 7. Wall mounting holder
- 8. [ ] key
- 9. [ ] key
- 10. [ °C / °F ] slide switch
- 11. [ AVG / GUST ] slide switch
- 12. [ TUNE ] key
- 13. [ ] key
- 14. [ V / ] key
- 15. [ / CH ] key
- 16. [ 12/24 ] key
- 17. [ SCAN ] key
- 18. [ RESET ] key
- 19. Battery compartment

## LCD DISPLAY

- 1. Time and calendar section
- 2. Indoor temperature & humidity reading section
- 3. Wind speed related reading section
- 4. Outdoor / Channel temperature & humidity reading section
- 5. Weather forecast icon
- 6. Weather index reading section

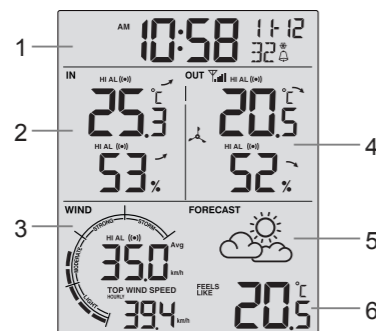

## WIRELESS SENSOR

1. Wind cup
2. Radiation shield
3. Battery compartment
4. Bottom case
5. Mounting clamps for bottom case
6. LED indicator
7. [ RESET ] key

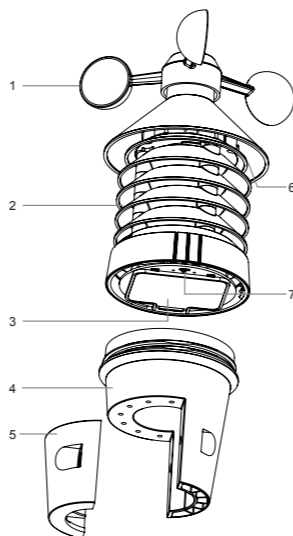

## SETUP & INSTALLATION

### INSTALL WIRELESS SENSOR

1. Turn the top case anti-clockwise to open.

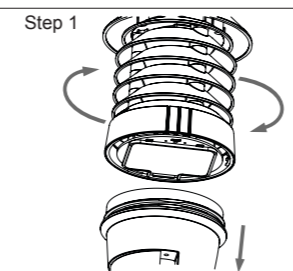

2. Remove the battery door.
3. Insert 3x AA size batteries into the battery compartment, then close the battery door.

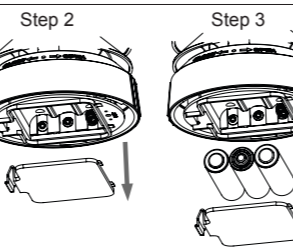

### NOTE

Make sure you insert the batteries in right way according to the polarity information marked on the battery compartment. Once installed, the LED indicator flashes and start transmit the signals.

4. Twist the Top case clockwise.

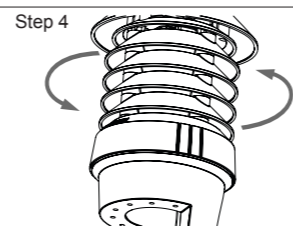

5. Mount the sensor on a pole by using the clamps with the big screws and nuts

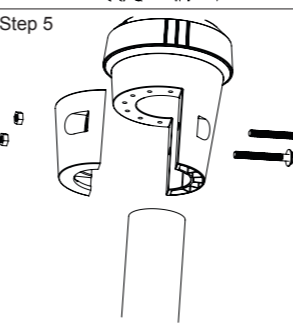

### MOUNTING GUIDELINES

- Secure the clamps (included) to a post or pole.
- Install the sensor at least 1.5m off the ground for better and more accurate wind measurements.
- Choose an open area within 100 meters from the LCD display console.

### NOTE:

- After replacing the batteries of the wireless sensor or the unit fails to receive wireless sensor signal of a specified channel, you need to press and hold [ SCAN ] key on the console to pair this sensor again.
- The building material and the position of the receiver and transmitter affect the effective range. So try various locations to obtain the best result.
- Place the units away from metal objects and electrical appliances to minimize the interference. Position the receiver and transmitter within the effective transmission range: 100m in usual circumstances.

## POWER UP THE LCD MONITOR

1. Remove the battery door and insert 2 x AA batteries into the battery compartment, according to the polarity mark on the battery compartment.
2. Once the batteries are installed, all LCD segment will be shown.
3. Replace the battery door.

### NOTE:

If no display appears on the LCD after installing the batteries, press the [ RESET ] key.

## INSTALL THE STAND

The unit is designed for desktop or wall mount for easy viewing. The following step is for stand installation.



Step 1



Step 2



Step 3

## SET LCD DISPLAY VIEWING ANGLE

Press [ V / ] key in normal mode to adjust LCD viewing angle to fit table stand or wall mount situation.

## USE THE LCD BACKLIGHT

In normal mode, press [ SNOOZE / LIGHT ] key to turn on backlight for 5 seconds.

## PAIRING ADDITIONAL WIRELESS SENSOR(S) (OPTIONAL)

This console can support up to 3 additional wireless thermo-hygro sensor(s). You can press [ SCAN ] key to search the corresponding channel's sensor manually. Once your sensor paired up, the sensor signal strength indicator and weather reading will appear on your console display.

### NOTE:

- The additional wireless sensor(s) is not included
- Select CH 1, 2 or 3 in the wireless sensor, channel 4 - 7 is not applicable on this model.
- Please check the additional sensor's user manual for more detail of the installation.

## VIEW MULTIPLE WIRELESS SENSOR CHANNELS (OPTIONAL)

1. In normal mode, press [ / CH ] key to switch the display between CH 1~3.
2. In normal mode, press and hold [ / CH ] key for 2 seconds to enter auto-cycle mode. After a "bl" sounds, it will alternately displays the CH 1~3 at 4 second intervals.
3. During auto-cycle mode, press [ / CH ] key again to stop auto-cycle mode and display the current channel.

## TIME & CALENDAR SETTING AND DISPLAY

### MANUAL SET TIME & DATE

1. In normal mode, press and hold [ ] key for 2 seconds to enter date and time setting mode.
2. Press [ / CH ] or [ V / ] key to adjust the setting.
3. Press [ ] key to enter the next setting.
4. The setting sequence: 12/24 format → hour → minute → second → year → DM/MD → month → day → ± 23 Hour offset → weekday language.
5. Press [ ] key or leave the unit for 60 seconds to complete the setting and return to normal mode.

Weekday language EN → FR → DE → ES → IT → NL → RU

### VIEW TIME

In normal mode, press [ ] key to switch between seconds and weekday display.

## ALARM TIME SETTING AND DISPLAY

1. In normal mode, press and hold [ ] key for 2 seconds until alarm hour digit flashes to enter alarm time setting mode.
2. Press [ / CH ] or [ V / ] key to change the value. Press and hold the key for quick-adjust.
3. Press [ ] key again to step the setting value to Minute with the Minute digit flashing.
4. Press [ / CH ] or [ V / ] key to adjust the value of the flashing digit.
5. Press [ ] key to save and exit the setting.

### NOTE:

- In alarm mode, the "!" icon will display on the LCD.
- The alarm function will turn on automatically once you set the alarm time.

## ACTIVATING ALARM AND TEMPERATURE PRE-ALARM FUNCTION

1. In normal mode, press [ ] key to show the alarm time for 5 seconds.
  2. When the alarm time displays, press [ ] key again to activate the alarm function.
- Or press [ ] key twice to activate the alarm with ice pre-alarm function.



Once the ice pre-alert activates, the pre-set alarm will sound and alert light will flash 30 minutes earlier if the outdoor temperature is below -3°C.

When clock reach the alarm time, alarm sound will start. Where it can be stopped by following operation:

- Auto-stop after 2 minutes alarming if without any operation and the alarm will activate again in the next day.
- By pressing [ SNOOZE / LIGHT ] key to enter snooze that the alarm will sound again after 5 minutes.
- By pressing and hold [ SNOOZE / LIGHT ] key for 2 seconds to stop the alarm and will activate again in the next day.
- By pressing [ ] key to stop the alarm and the alarm will activate again in the next day.

## NOTE:

- The snooze could be used continuously in 24 hours.
- During the snooze, the alarm icon "!" will keep flashing.

## WIRELESS SENSOR SIGNAL RECEIVING

The console display signal strength for the wireless wind speed 3-IN-1 sensor, as per table below:

No signal	Weak signal	Good signal

1. If the signal has discontinued and does not recover within 15 minutes, the signal icon will disappear. The wind speed, temperature and humidity will display "- -" for the corresponding channel.
2. If the signal does not recover within 1 hour, the wind speed, temperature and humidity will display "Er" for the corresponding channel, if over 48 hours, the "Er" display will become permanent. You need to replace the batteries and then press [ SCAN ] key to pair up the sensor again.

## VIEW THE OUTDOOR CHANNEL (Optional feature for additional thermal-hygro sensors)

This console can pair with a wireless wind speed 3-IN-1 sensor and up to 3 wireless thermal-hygro sensors. If you have 2 or more sensors, you can press [ / CH ] key to switch between different wireless channels in normal mode, or press and hold [ / CH ] key for 2 seconds to toggle auto-cycle mode to display the connected channels at 4 seconds interval and the "!" icon will show on the display.

During auto-cycle mode, press [ / CH ] key to stop auto cycle and display the current channel.

On display Icon		e.g.
	3-IN-1 sensor	Thermal-hygro sensor

## TEMPERATURE AND HUMIDITY TREND

The Barometric pressure, temperature and humidity trend indicator shows the trends of changes in the forthcoming few minutes. Arrows indicate a rising, steady or falling trend.

Arrow indicator	Trend	Rising	Steady	Falling

### NOTE:

- If no signals are received or the transmission is interfered, "- -" will appear on the LCD.
- Relocated the console or transmitter in other positions and make sure the transmission is within the effective range of 100m straight distance approx.

## WEATHER INDEX

At the WEATHER INDEX section, you can press [ INDEX ] key to view the weather index in this sequence: FEELS LIKE → HEAT INDEX → DEW POINT → WIND CHILL.

## SMART FEELS LIKE

The feels like temperature index determines how the outdoor temperature would actually feel like.

## HEAT INDEX

The heat index, which is determined by the wireless wind speed 3-IN-1 sensor's temperature & humidity data, when the temperature is between 27°C (80°F) and 50°C (120°F).

Heat Index	Warning	Explanation
27°C to 32°C (80°F to 90°F)	Caution	Possibility of heat exhaustion
33°C to 40°C (91°F to 105°F)	Extreme Caution	Possibility of heat dehydration
41°C to 54°C (106°F to 129°F)	Danger	Heat exhaustion likely
≥55°C (≥130°F)	Extreme Danger	Strong risk of dehydration / sun stroke

## DEW POINT

- The dew point is the temperature below which the water vapor in air at constant barometric pressure condenses into liquid water at the same rate at which it evaporates. The condensed water is called dew when it forms on a solid surface.
- The dew point temperature is determined by the temperature & humidity data from wireless sensor.

## WIND CHILL

A combination of the wireless sensor's temperature and wind speed data determines the current wind chill factor.

## WEATHER FORECAST

The built-in barometer can notice atmosphere pressure changes. Based on the data collected, it can predict the weather conditions in the forthcoming 24 ~ 72 hours.

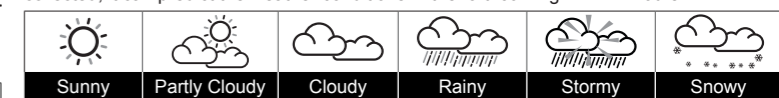

### NOTE:

1. The accuracy of a general pressure-based weather forecast is about 70% to 75%.
2. The weather forecast is meant for the next 24 ~ 72 hours, it may not necessarily reflect the current situation.
3. The **Snowy** weather forecast is not based on the atmospheric pressure, but based on the temperature of outdoor sensor. When the current channel temperature is below -3°C, the **Snowy** weather indicator will be displayed on the 24 HOUR FORECAST display section.

## WIND SPEED

### TO SELECT WIND SPEED UNIT

- In normal mode, press and hold [ **WIND** ] key for wind speed unit selection.
- Press [ **V / O** ] or [ **A / CH** ] key to switch between: **mph, m/s, km/h, knots**.
- Press [ **WIND** ] key to confirm unit selection and back to normal mode.

### TO SELECT THE WIND DISPLAY MODE

Use the [ **AVG / GUST** ] slide switch to switch between **AVERAGE** and **GUST** wind speed. In normal mode, press [ **WIND** ] key to switch between **HOURLY, DAILY, MONTHLY** and **YEARLY** top wind speed record.

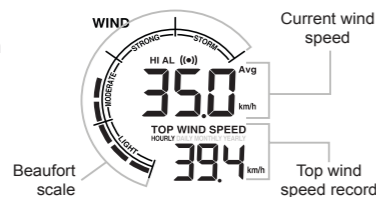

## BEAUFORT SCALE

The Beaufort scale is an international scale of wind velocities ranging from 0 (calm) to 12 (Hurricane force).

Display	Beaufort Scale	Description	Wind Speed	Land Condition
	0	Calm	< 1 km/h	Calm. Smoke rises vertically.
			< 1 mph	
			< 1 knot	
	1	Light air	< 0.3 m/s	Smoke drift indicates wind direction. Leaves and wind vanes are stationary.
			1.1 ~ 5.5 km/h	
			1 ~ 3 mph	
	2	Light breeze	1 ~ 3 knot	Wind felt on exposed skin. Leaves rustle. Wind vanes begin to move.
			0.3 ~ 1.5 m/s	
			4 ~ 6 knot	
	3	Gentle breeze	5.6 ~ 11 km/h	Leaves and small twigs constantly moving, light flags extended.
			4 ~ 7 mph	
			7 ~ 10 knot	
	4	Moderate breeze	1.6 ~ 3.3 m/s	Dust and loose paper raised. Small branches begin to move.
			12 ~ 19 km/h	
			13 ~ 17 mph	
	5	Fresh breeze	11 ~ 16 knot	Branches of a moderate size move. Small trees in leaf begin to sway.
			5.5 ~ 7.9 m/s	
			18 ~ 24 mph	
	6	Strong breeze	29 ~ 38 km/h	Large branches in motion. Whistling heard in overhead wires. Umbrella use becomes difficult. Empty plastic bins tip over.
			17 ~ 21 knot	
			22 ~ 27 knot	
	7	High wind	10.8 ~ 13.8 m/s	Whole trees in motion. Effort needed to walk against the wind.
			50 ~ 61 km/h	
			31 ~ 38 mph	
	8	Gale	28 ~ 33 knot	Some twigs broken from trees. Cars veer on road. Progress on foot is seriously impeded.
			13.9 ~ 17.1 m/s	
			34 ~ 40 knot	
	9	Strong gale	62 ~ 74 km/h	Some branches break off trees, and some small trees blow over. Construction / temporary signs and barricades blow over.
			39 ~ 46 mph	
			41 ~ 47 knot	
	10	Storm	20.8 ~ 24.4 m/s	Trees are broken off or uprooted, structural damage likely.
			89 ~ 102 km/h	
			55 ~ 63 mph	
	11	Violent storm	48 ~ 55 knot	Widespread vegetation and structural damage likely.
			103 ~ 117 km/h	
			64 ~ 73 mph	
	12	Hurricane force	28.5 ~ 32.6 m/s	Severe widespread damage to vegetation and structures. Debris and unsecured objects are hurled about.
			≥ 118 km/h	
			≥ 74 mph	
			≥ 64 knot	
			≥ 32.7m/s	

## MAX / MIN RECORD

The console can record the accumulated MAX / MIN weather data with the corresponding time stamp for you to easy review.

### TO VIEW THE ACCUMULATED MAX / MIN

In normal mode, press [ **MEM** ] key to check MAX/MIN records. The display sequence is: MAX indoor temperature → MIN indoor temperature → MAX indoor humidity → MIN indoor humidity → MAX outdoor (or current channel) temperature → MIN outdoor (or current channel) temperature → MAX outdoor (or current channel) humidity → MIN outdoor (or current channel) humidity → MAX feels like temperature → MIN feels like temperature → MAX heat index → MIN heat index → MAX dew point → MIN dew point → MAX wind chill → MIN wind chill → MAX wind speed → MAX wind gust.

## TO CLEAR THE MAX / MIN RECORDS

When viewing the record, press and hold [ **MEM** ] key for 2 seconds to reset the current MAX / MIN record of specify weather display section.

## PAST HISTORY RECORD

The LCD monitor automatically stores past 24 hours weather data.

- When the **HOURLY** top wind speed shown, press [ **HISTORY** ] key to check the beginning of the current hour's weather data, e.g. the current time is 7:25 am, March 8, the display will show the data of 7:00am, March 8.
- Press [ **HISTORY** ] key repeatedly to view older readings of the past 24 hours (-01H to -24H).

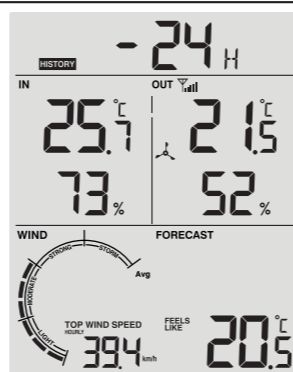

When the <b>DAILY</b> top wind speed shown, press the [ <b>HISTORY</b> ] key repeatedly to check back the MAX wind speed for the past 31 days.		TOP WIND SPEED DAILY	5.1 km/h
TOP WIND SPEED Daily history mode			
When the <b>MONTHLY</b> top wind speed shown, press the [ <b>HISTORY</b> ] key repeatedly to check back the MAX wind speed for the past 12 months.		TOP WIND SPEED MONTHLY	13.1 km/h
TOP WIND SPEED Monthly history mode			
When the <b>YEARLY</b> top wind speed shown, press the [ <b>HISTORY</b> ] key repeatedly to check back the MAX wind speed for the past 3 years.		TOP WIND SPEED YEARLY	39.7 km/h
TOP WIND SPEED Yearly history mode			

### NOTE:

- The LCD will also display the " **HISTORY** " icon, history data records with time & date.
- All the Top wind speed historical reading depend on the current display mode (Gust or Avg wind speed).

## WEATHER ALERT SETTING

Weather Alert can alert you of certain weather conditions. Once the alert criterion is met, the alarm sound will activate and the LCD's alert icon will flash.

### TO SET ALERT

- In normal mode, press [ **ALERT** ] key to enter alert setting mode.
- Press [ **A / CH** ] or [ **V / O** ] key to select the IN / OUT or channel in following sequence: IN → OUT → CH 1 → CH 2 → CH 3.
- Once selected, press [ **ALERT** ] key to select the alert type in following sequence: Temperature High Alert → Temperature Low Alert → Humidity High Alert → Humidity Low Alert → Average Wind Speed (for OUT only).
- Press [ **A / CH** ] or [ **V / O** ] key to adjust the value or press and hold the key to change rapidly.

Alert setting parameter	Setting Range	Display Section	Default value
In temperature High Alert	-39.9°C ~ 70°C	Indoor or Outdoor / CH temperature & humidity section	40°C
In temperature Low Alert	-40°C ~ 69.9°C		0°C
Out temperature High Alert	-39.9°C ~ 80°C		40°C
Out temperature Low Alert	-40°C ~ 79.9°C		0°C
Humidity High Alert	2% ~ 99%		80%
Humidity Low Alert	1% ~ 98%		40%
Average Wind Speed	0.1m/s ~ 50m/s	Wind speed section	17.2m/s

- Press [ **ALERT** ] key toggle the regarding alert on / off.



e.g. Both outdoor temperature High & Low alert alarm are on



e.g. Both outdoor temperature High & Low alert alarm are off

- Press [ **ALERT** ] key to step to next parameter or channel selection.
- Press and hold [ **ALERT** ] key for 2 seconds or press any key in front to save alert on / off status and back to normal mode. Please note the display will also return back to normal mode. If no key is pressed in 30 seconds.

## TO SILENCE THE ALERT ALARM

Press [ **SNOOZE / LIGHT** ] key to silence the alert alarm or let the alarm automatically turn off after 2 minutes.

### NOTE:

- Once the alert is triggered, the alarm will sound for 2 minutes and the related alert icon and readings will flash.
- If the alert alarm is automatically off after 2 minutes, the alert icon and readings will still keep flash until the weather reading is out of the alert range.
- The weather alert will sound again when the weather readings falls into the alert range again

## CALIBRATION

- In normal mode, press [ **TUNE** ] key to enter calibration mode and the current channel's offset value will shown on the display.

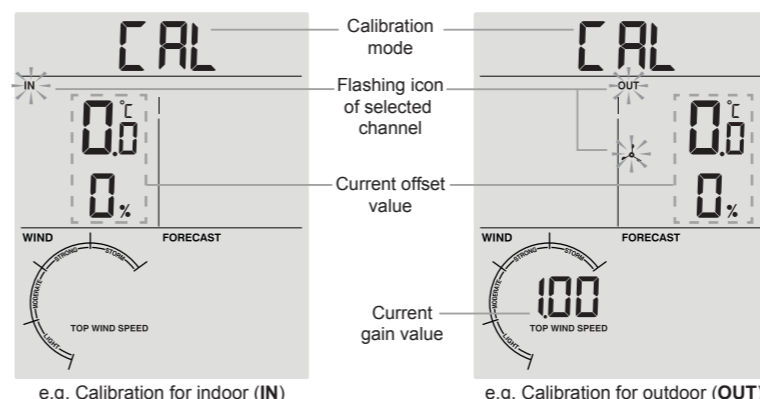

e.g. Calibration for indoor (IN)

e.g. Calibration for outdoor (OUT)

- Press [ **A / CH** ] or [ **V / O** ] key to select the IN / OUT or channel in sequence: IN → OUT → CH 1 → CH 2 → CH 3.
- Once selected, press [ **TUNE** ] key to select the offset in sequence: Temperature → Humidity → Wind speed gain (only available for **OUT** channel).
- Press [ **A / CH** ] or [ **V / O** ] key to adjust the offset value or press and hold the key to change rapidly:
  - For temperature: Measured value (e.g.: 25.2°C) + Offset value (e.g.: 2.1) = Calibrated value (27.3°C).
  - For humidity: Measured value (e.g.: 55%) + Offset value (e.g.: 5) = Calibrated value (60%).
  - For wind speed: Measured value (e.g.: 10.5km/h) x Gain factor (e.g.: 1.2) = Calibrated value (12.6km/h).

Calibration parameter	Offset range	Increments	Default value
Temperature (IN / OUT / CH)	+20 to -20°C (+36 to -36°F)	1 decimal place	0.0
Humidity (IN / OUT / CH)	+20 to -20%	1%	0
Wind speed gain factor (OUT)	0.75 ~ 1.50	0.01	1.00

- Press [ **TUNE** ] key to step to next parameter or channel selection.
- Press and hold [ **TUNE** ] key for 2 seconds or press any key in front to save alert on / off status and back to normal mode. If 30 seconds without pressing any key it will also back to normal mode.

### NOTE:

- The weather index is based on calibrated wind speed, temperature and humidity values.
- The purpose of calibration is to fine tune or correct for the sensor(s) error associated with the devices margin of error. Errors can occur due to electronic variation (example, the temperature sensor is a resistive thermal device or RTD, the humidity sensor is a capacitance device), or degradation (contamination of sensors).
- Calibration is only useful if you have a known calibrated source you can compare it against, and is optional. This section discusses practices, procedures and sources for sensor calibration to reduce manufacturing and degradation errors. Do not compare your readings obtained from sources such as the internet, radio, television or newspapers. The purpose of your weather station is to measure conditions of your surroundings, which vary significantly from location to location.

## LOW BATTERY ICON

When the battery indicator " " appear on the clock section or the LCD becomes dim, replace with 2 new AA size batteries at once; while If the low battery indicator " " appear in the outdoor section, it indicates that the battery power of the transmitter is not enough, and you should replace with 3 new AA size batteries at once.

## IMPORTANT NOTE

- The LCD Monitor is intended to be used only indoors.
- Do not subject the unit to excessive force, shock, dust, temperature or humidity.
- Do not cover the ventilation holes with any items such as newspapers, curtains etc.
- Do not immerse the unit in water. If you spill liquid over it, dry it immediately with a soft, lint-free cloth.
- Do not clean the unit with abrasive or corrosive materials.
- Do not tamper with the unit's internal components. This invalidates the warranty.
- Only use fresh batteries. Do not mix new and old batteries.

## SPECIFICATIONS

### LCD MONITOR

Dimensions (W x H x D)	95 x 155 x 23mm (size exclude table stand)
Main power	2 x AA size 1.5V batteries
Operating temperature range	-5°C to 50°C ( 23°F to 122°F )
Temperature display range (In / Outdoor)	-40°C to 70°C (-40°F to 158°F)
Humidity display range (In / Outdoor)	RH 1% to 99 %
Wind speed display range	0 ~ 112mph, 50m/s, 180km/h, 97knots
Resolution of temperature	1 decimal place (°C/°F)
Resolution of humidity	1%
Resolution of wind speed	1 decimal place (mph, m/s,km/h or knots)
Support sensors	1 Wireless wind speed 3-in-1 sensor and up to 3 Wireless hygro-thermo sensors

### WIRELESS SENSOR

Dimensions (W x H x D)	136 x 249 x 136mm
Main power	3 x AA size 1.5V batteries (Lithium battery recommended for low temperature environment)
Operating temperature range	-40°C to 60°C ( -40°F to 140°F )
Operating humidity range	RH 1% to 99 % (non-condensing)
RF frequency	917 MHz
RF transmission range	100 meters

Ames Australasia warrants that this product will be free from defects in workmanship and materials for 2 years. If a defect in material or workmanship becomes evident during that period, Ames Australasia will, at its option, either, repair the product (or pay for the costs of repair of the product); replace the product; or refund to the customer the purchase price paid by the customer for the product. In the event of such a defect, the product should be returned to the place of purchase, together with proof of purchase for repair, replacement or refund. Any handling and transportation (and other expenses incurred in claiming under this guarantee) are not covered by this guarantee and will not be borne by Ames Australasia. The obligation of Ames Australasia under this guarantee is limited to the circumstances set out above and is subject to; the customer being able to evidence the acquisition of the product, the purchase price paid for the product and the relevant defect in materials or workmanship; the product not having been altered, tampered with or otherwise dealt with by any person in a manner other than as intended in respect of the relevant product; and the product not having been used or applied in a manner that is contrary to customary usage or application for the relevant product or contrary to any stated instructions or specification of Ames Australasia. Our goods come with guarantees that cannot be excluded under the Australian Consumer Law. You are entitled to a replacement or refund for a major failure and for compensation for any other reasonably foreseeable loss or damage. You are also entitled to have the goods repaired or replaced if the goods fail to be of acceptable quality and the failure does not amount to a major failure. The benefits given by this guarantee are in addition to the other rights and remedies which might be available to the customer under any law in relation to goods or services to which this guarantee relates.

For further information contact us on  
Australia Free Call: 1800 335 019 New Zealand: 09 427 6042

**AMES Australasia**  
ABN 89 169 427 061  
Level 1, 660 Doncaster Road, Doncaster,  
Victoria 3108. Australia

www.nylex.com.au

